



Pluton

Suitable for suspended or plasterboard ceiling installation in shower/bathrooms or any areas where humidity and/or dust are present. The unit is sealed against pressurised water to IP65 from below via a 2mm gasket at the ceiling interface. Other features include tempered, sand-blasted safety glass and flexible mounting blades. Supplied with long life lamps (10,000 hours) as standard.

- Low voltage halogen
- IP65
- Tempered glass
- Suitable for zone 1-3 installation
- White painted finish

Pluton

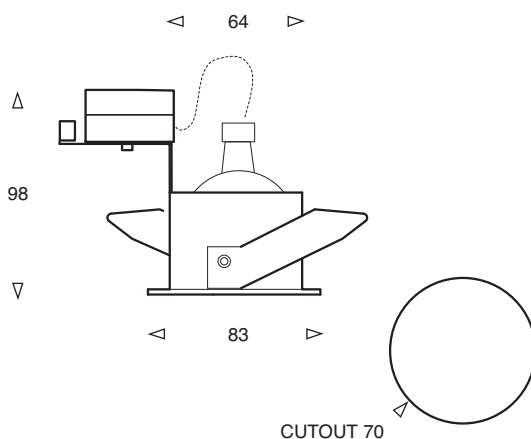

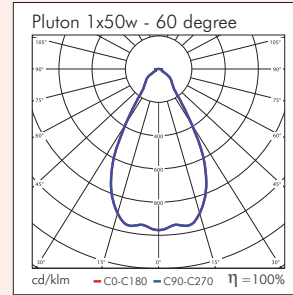
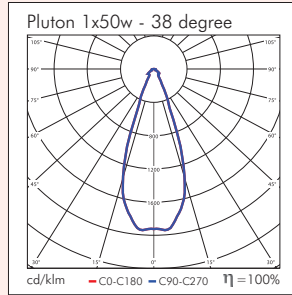
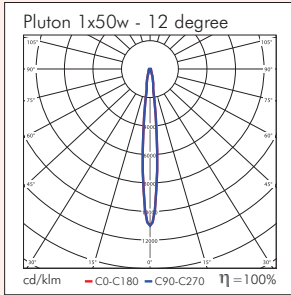
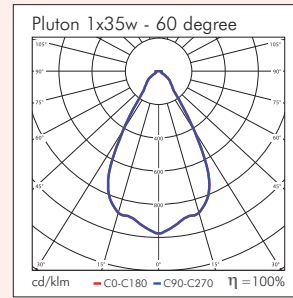
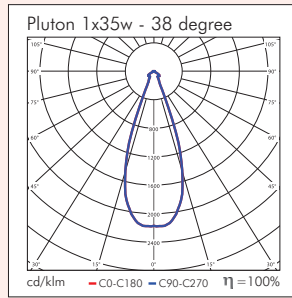
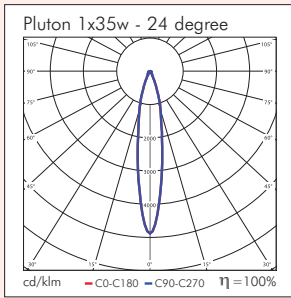

Product	Available Options	Power	Weight	Height	Diameter	Cutout
PLU-83	-20,-35,-50,-12,-24,-38,-60	20 - 50w	0.25kg	98	83	70

Options	Code Suffix
Lamp Wattage (20/35/50)	-20,-35,-50
Lamp Beam Angle (12/24/38/60)	-12,-24,-38,-60

Light Source	Code		Power	Lampholder	Colour Temp	Output
	ILCOS	LBS				
Longlife LV Halogen Dichroic 12°	HRGS	QR-CBC51	50w	GU5.3	100/30k	6500 cd
Longlife LV Halogen Dichroic 24°	HRGS	QR-CBC51	20-50w	GU5.3	100/30k	880/1700/2700 cd
Longlife LV Halogen Dichroic 36°	HRGS	QR-CBC51	20-50w	GU5.3	100/30k	450/950/1500 cd
Longlife LV Halogen Dichroic 60°	HRGS	QR-CBC51	35-50w	GU5.3	100/30k	400/600 cd